

SPECIFICATIONS

SW280WA01/02 11" low profile, die cast, flat cone subwoofers, 4/8 ohm

11" High Performance Low Profile Subwoofer Units.

Innovative design with dual rubber surround suspension and flat sandwich cone. Recommended for high end audio applications, where build-in depth is limited. A typical application is for high performance in-wall systems.

FEATURES

- Dual surround suspension and flat cone design to minimize build-in depth
- Glass fiber / PMI foam sandwich cone to maximize bending stiffness leading to improved frequency response
- Innovative dual cone design to allow magnet mounting "inside" the cone resulting in reduced overall depth
- Balanced Drive motor structure for optimal drive force symmetry resulting in largely reduced even order harmonic distortion
- Rigid die cast chassis with extensive venting for lower air flow speed, reducing audible distortion
- Vented center pole with dual flares for reduced noise level at large cone excursions
- Heavy-duty vented fiber glass voice coil former to reduce mechanical losses resulting in better dynamic performance and low-level details
- Built-in alu field-stabilizing ring for reduced distortion at high levels
- Low-loss suspension (high Qm) for better reproduction of details and dynamics
- Black plated motor parts for better heat transfer to the surrounding air
- Gold plated terminals to ensure long-term trouble free connection
- Delivered with foam gasket attached for hassle-free mounting and secure cabinet sealing



NOMINAL SPECIFICATIONS

Notes	Parameter	SW280WA01		SW280WA02		Unit
		Before burn-in	After burn-in	Before burn-in	After burn-in	
	Nominal size	11		11		[inch.]
	Nominal impedance	4		8		[ohm]
	Recommended max. upper frequency limit	400		400		[Hz]
1, 3	Sensitivity, 2.83V/1m (calculated from T/S parameters)	86		83		[dB]
2	Power handling, short term, IEC 268-5, no additional filtering					[W]
2	Power handling, long term, IEC 268-5, no additional filtering					[W]
2	Power handling, continuous, IEC 268-5, no additional filtering	200		200		[W]
	Effective radiating area, S _d	335		335		[cm ²]
3, 6	Resonance frequency (free air, no baffle), F _s	26.6		26.9		[Hz]
	Moving mass, incl. air (free air, no baffle), M _{ms}	137.6		134.2		[g]
3	Force factor, B _{xl}	13.4		16.6		[N/A]
3, 6	Suspension compliance, C _{ms}	0.26		0.26		[mm/N]
3, 6	Equivalent air volume, V _{as}	41.4		41.4		[lit.]
3, 6	Mechanical resistance, R _{ms}	3.7		3.7		[Ns/m]
3, 6	Mechanical Q, Q _{ms}	6.2		6.1		[-]
3, 6	Electrical Q, Q _{es}	0.44		0.52		[-]
3, 6	Total Q, Q _{ts}	0.41		0.48		[-]
4	Voice coil resistance, R _{DC}	3.4		6.3		[ohm]
5	Voice coil inductance, L _e (measured at 1 kHz)	1.4				[mH]
	Voice coil inside diameter	39		39		[mm]
	Voice coil winding height	17		17		[mm]
	Air gap height	5		5		[mm]
	Theoretical linear motor stroke, X _{max}	±6		±6		[mm]
	Magnet weight					[kg]
	Total unit net weight excl. packaging					[kg]
3, 5	K _{rm}					[mohm]
3, 5	E _{rm}					[-]
3, 5	K _{xm}					[mH]
3, 5	E _{xm}					[-]

Note 1 Measured in infinite baffle.

Note 2 Tested in free air (no cabinet).

Note 3 Measured using a semi-constant current source, nominal level 2 mA.

Note 4 Measured at 25 deg. C

Note 5 It is generally a rough simplification to assume that loudspeaker transducer voice coils exhibit the characteristics of an inductor. Instead it is a far more accurate approach to use the more advanced model often referred to as the "Wright empirical model", also used in LEAP-4 as the TSL model (www.linearx.com), involving parameters K_{rm}, E_{rm}, K_{xm}, and E_{xm}. This more accurate transducer model is described in a technical paper [here at our web site](#).

Note 6 After burn-in specifications are measured 12 hours after exiting the transducer by a 20 Hz sine wave for 2 hours at level 10 VRMS. Units are not burned in before shipping.

SPECIFICATIONS

SW280WA01/02 11" low profile, die cast, flat cone subwoofers, 4/8 ohm

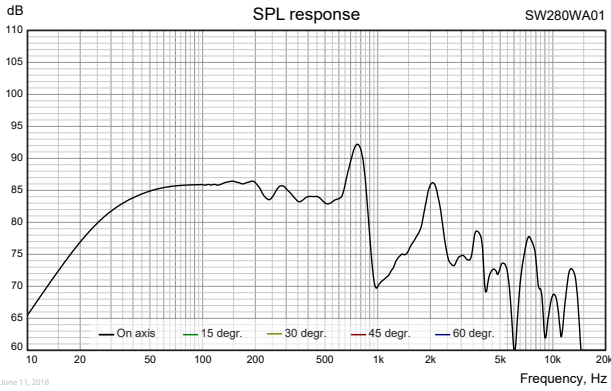

Important!
Please observe that graphs on the left side of this page and the below text files for download are actual measurements of the drivers measured in infinite baffle and without any enclosure. Measuring the drivers in a finite baffle (like the baffle of most speaker cabinets) and in any size of enclosure will lead to different response curves.

[Download SW280WA01 on-axis SPL response as .txt file](#)

Measuring conditions, SPL
Driver mounting: Flush in infinite baffle, back side open (no cabinet)
Microphone distance: 1.0 m
Input signal: 2.83 VRMS stepped sine wave
Smoothing: 1/6 oct.

[Download SW280WA02 on-axis SPL response as .txt file](#)

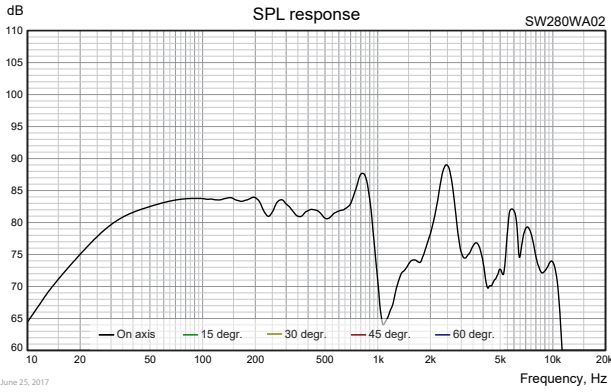

[Download SW280WA01 Impedance response as .txt file](#)

Measuring conditions, impedance
Driver mounting: Free air, no baffle, back side open (no cabinet)
Input signal: Stepped sine wave, semi-current-drive, nominal current 2 mA
Smoothing: None

[Download SW280WA02 Impedance response as .txt file](#)

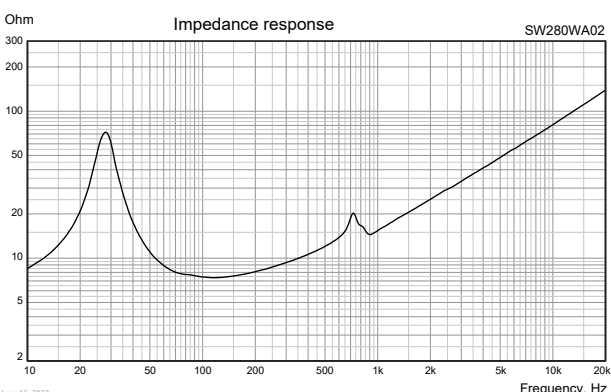
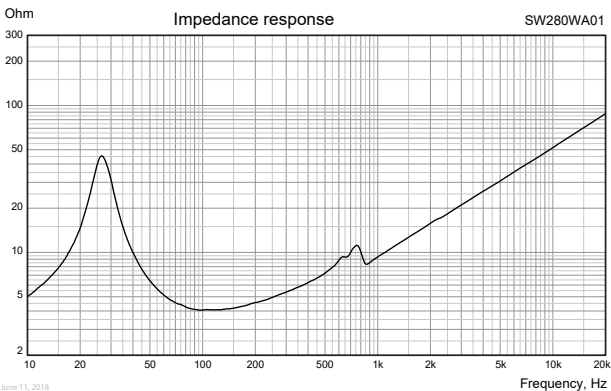

SPECIFICATIONS



SW280WA01/02 11" low profile, die cast, flat cone subwoofers, 4/8 ohm

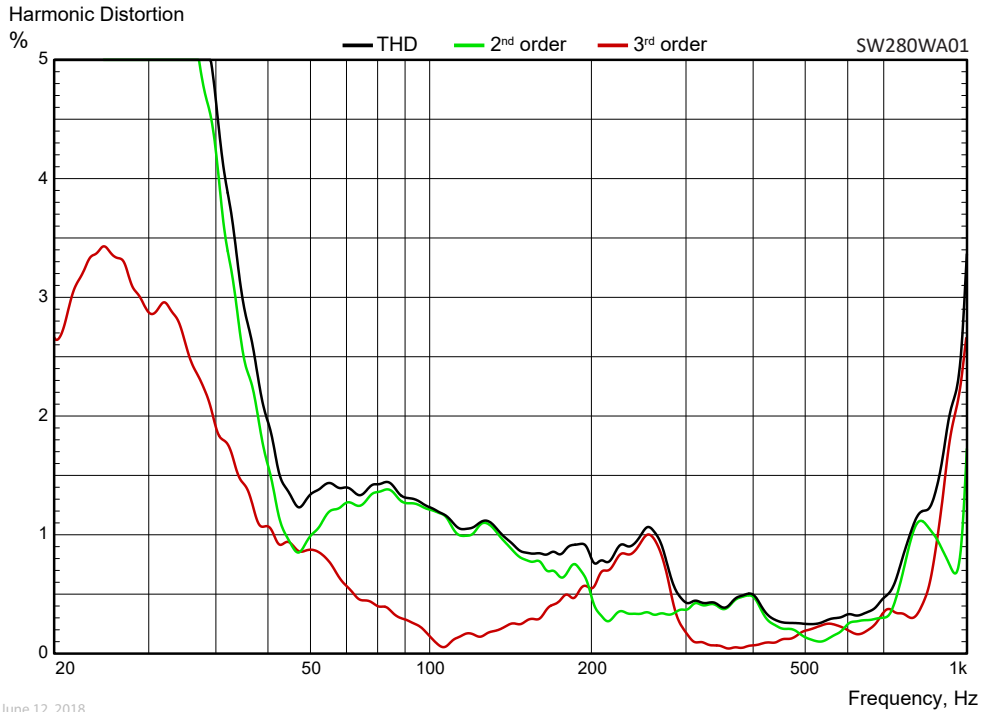

June 12, 2018

Measuring conditions, Harmonic Distortion

Driver mounting: In sealed, heavily stuffed enclosure, internal volume 10 lit.
Microphone distance: 0.5 m
Input signal: Stepped sine wave, 6.9 VRMS (SW280WA01) / 9.8 VRMS (SW280WA02)
Smoothing: 1/6 oct.

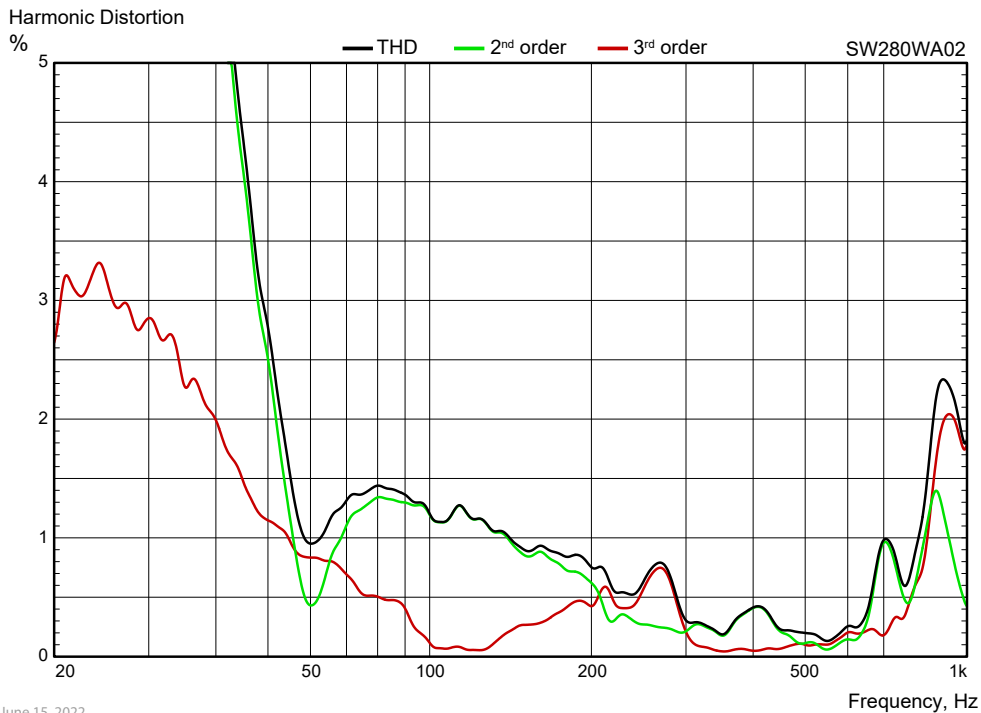

June 15, 2022

SPECIFICATIONS

SW280WA01/02 11" low profile, die cast, flat cone subwoofers, 4/8 ohm

OUTLINE DRAWING (nominal dimensions)

Dimensions in mm

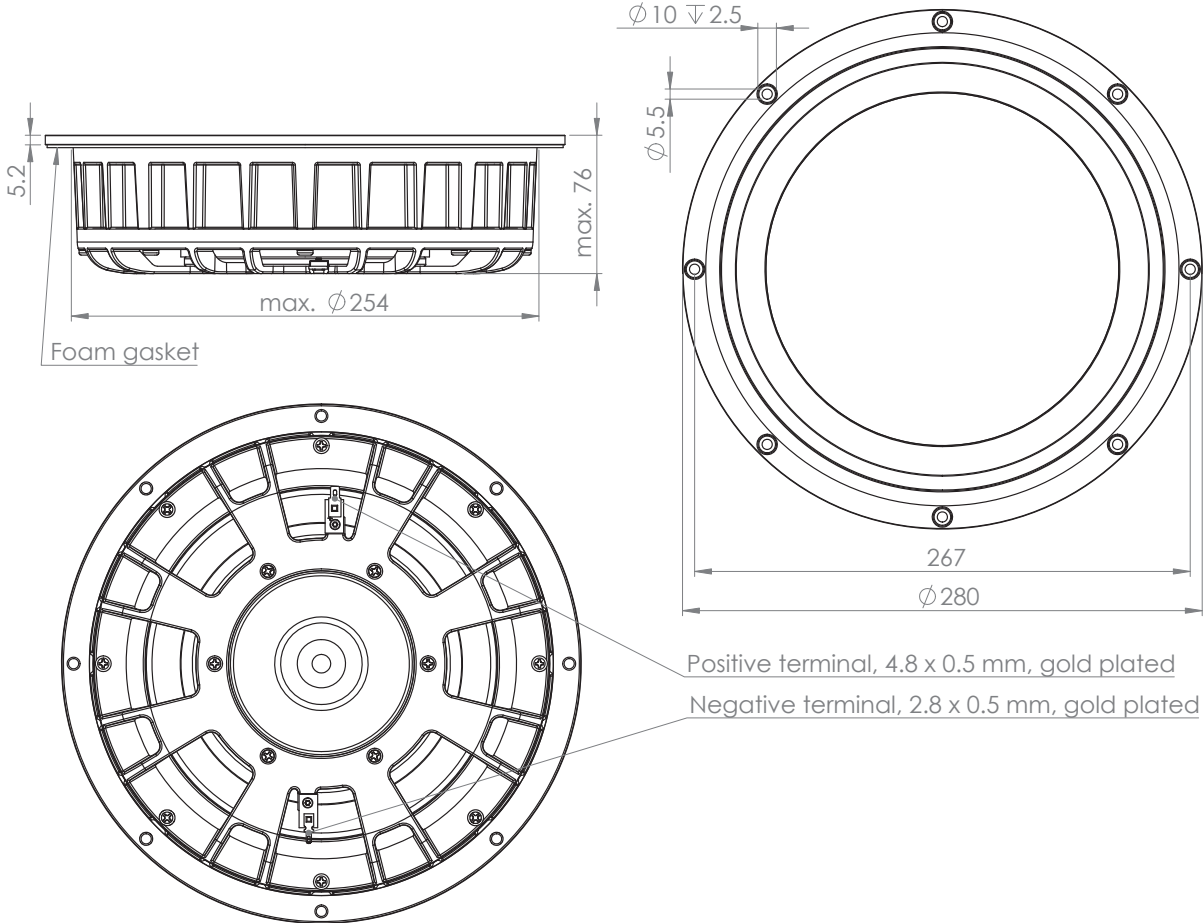

PACKAGING AND ORDERING INFORMATION

Part no. SW280WA01-01	4 ohm version, individual packaging (one piece per box)
Part no. SW280WA02-01	8 ohm version, individual packaging (one piece per box)

Latest update: June 23, 2022